

3.5-CHANNEL GYRO SYSTEM **S105G**

ALLOY INFRARED REMOTE CONTROL HELICOPTER

To avoid copter's damage and player's injury, please read this instruction before flying!

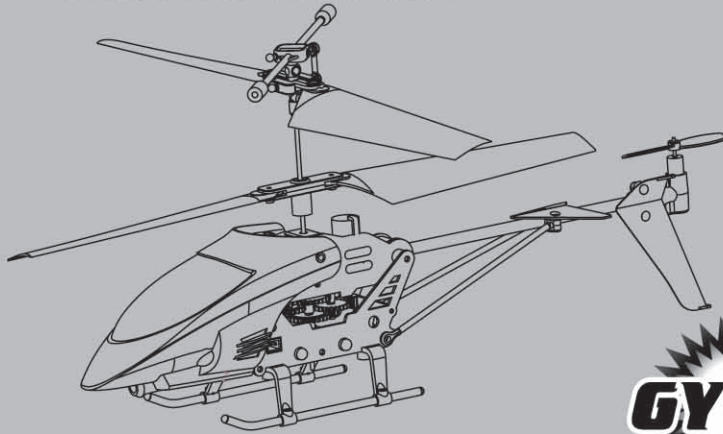

NO.S105G

PACK LIST

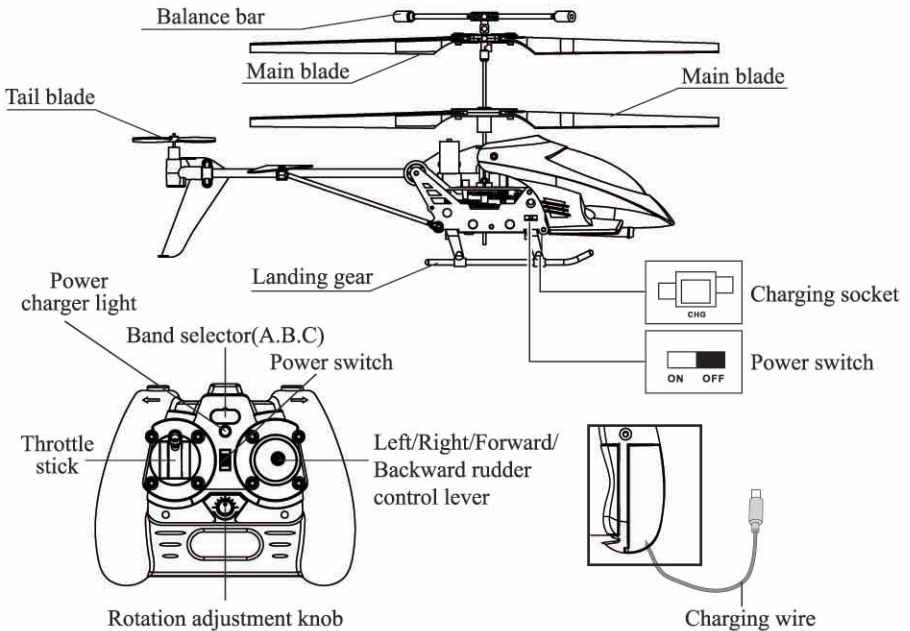

BATTERY INSTALLATION & CHARGING

Battery Installation- Transmitter

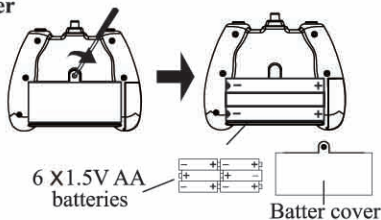

Open the cover of battery case insert 6 batteries (size AA) properly followed by polar indicator, shut the cover of battery case.

Charging Helicopter

A、controller charging

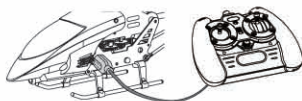

B、USB charging

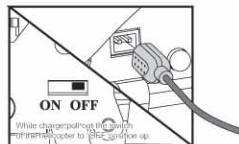

1. Move the power switch on the helicopter to the "OFF" position.
2. **Charging way A:** Put down the charging wire cover of the back controller and put out the charging wire, then put into the interface of the helicopter, the yellow light on the controller will change red. The charging time is about 40-50 minutes. The glisten red light will change normal light. Then the helicopter is fully charged.

Charging way B: Put the USB charging wire into the computer USB interface, the charging wire will be light. Put the other side of USB charging wire into the helicopter's interface, USB charging wire light will be turn off. The charging time is about 40-50 minutes. Charging wire light will turn on. Then the helicopter is fully charged.

Charging time can be 40-50 minutes flying for about 6-7 minutes

FLYING YOUR HELICOPTER

- Set the Band Selector on the Transmitter and Helicopter to the same frequency.
- Move the Power Switch on the helicopter to the ON position, the power indicator will light up.
- Place the helicopter on the ground with the tail pointed towards you.
- When the helicopter received the transmit, the led of circuit board will turn light.

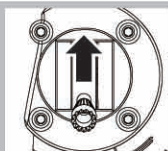

LEFT HAND
MANIPULATE

1. Turn on the switch.
2. The motive handle (accelerator) must be pushed to the maximum control route of travel first, then adjust it to zero (lowest), after that, you can turn on the power of helicopter to fly the normal operation.

Hover up and down

When the helicopter flies steadily, you can slowly push the throttle stick up to make helicopter fly higher, or release the stick a bit to make helicopter fly lower. Only small amounts of stick position change are required for smooth flying.

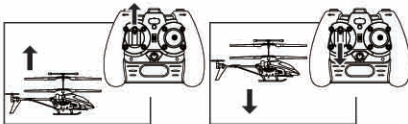

Turn counter clockwise and clockwise

Hold the helicopter at a height. Push the rudder stick toward left to turn counter clockwise, and push the rudder stick toward right to turn clockwise.

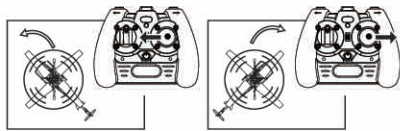

Forward

When you push up the right control lever (steering rudder), the nose incline to down, the helicopter is moving to forward.

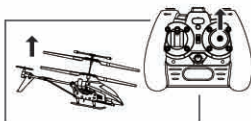

Backward

When you push down the right control lever (steering rudder), the nose incline to up, the helicopter is moving to backward.

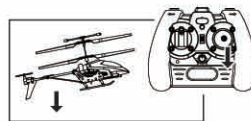

Note: If the helicopter rotates whilst in operation, please use the rudder trim to adjust.

If the helicopter spins during flight, follow the procedure below to stop the rotation.

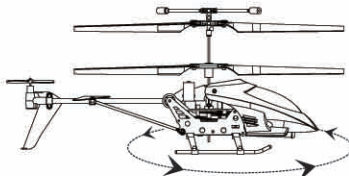

Helicopter rotates anticlockwise



Clockwise rotation vernier adjustment knob

Note: Adjust the knob as required until the rotation has stopped.

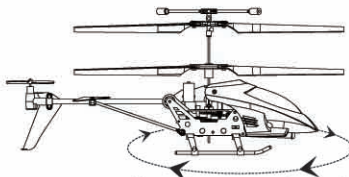

Helicopter rotates clockwise

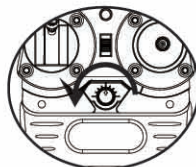

Counterclockwise rotation vernier adjustment knob

Note: Adjust the knob as required until the rotation has stopped.

OPERATION:

- * Don't operate the helicopter under the direct sun or strong lighting;it will affect the control system of your helicopter.
- * Don't cover the lens of the transmitter.No signal will be released while you cover the lens.
- * Don't stick any other label onto the helicopter;the other label will affect receiving of IR signal.
- * The product uses light-minded materials, it will easy to damage if operate incorrectly, tumble or bump or another factor will shatter the product.
- * Motor heating components, don't touch, avoid scald.

ENVIRONMENT FOR FLIGHT:

- 1.Indoor environment with calm air condition.Beware of the air circulation from the air-conditioner.
- 2.Space area:It is recommended to have to have space area over 20ft(W) x 30ft(L) x 10ft(H).
- 3.Safety area:It is recommended that there is no electric fan,air-conditioner,reading lamp or other dangerous objects to flying.

SPARE PARTS LIST

Order by item number from local distributors.



S105G-01
Head cover



S105G-02
Main blade



S105G-03
Tail decoration



S105G-04
Connect buckle



S105G-05
Balance bar



S105G-06
Tail lade



S105G-07
Helicopter corpus



S105G-08
Ascend and Descend



S105G-09
Gear



S105G-10
Tail support pipe



S105G-11
Main frame metal part A



S105G-12
Main frame metal part B



S105G-13
Main shaft



S105G-14
Chopper tail unit module



S105G-15
Main shaft pipe



S105G-16
Motor A



S105G-17
Motor B



S105G-18
Circuit board



S105G-19
3.7V Li-Poly

三通道陀螺仪遥控系列

S105G

合金红外线遥控直升机

為了避免直升機損壞、傷及自己或他人，在使用之前，請仔細閱讀本說明書。

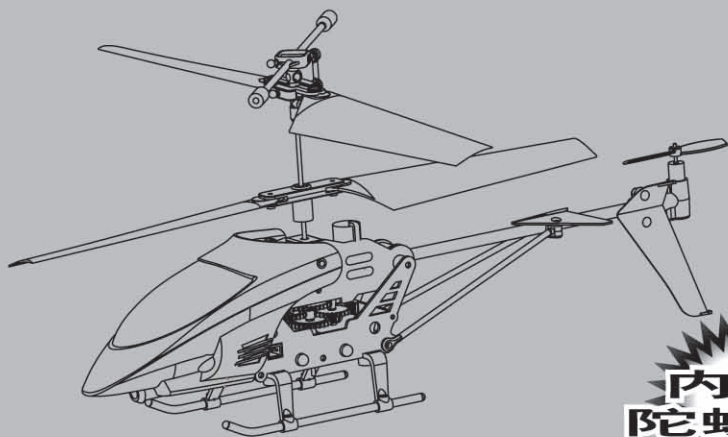

NO.S105G

組件名稱

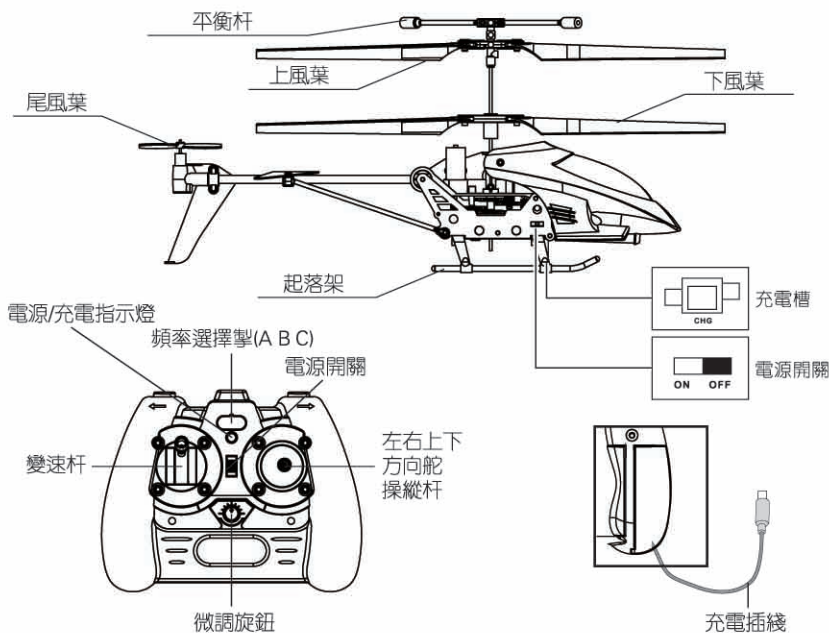

電池安裝及充電

遙控器電池安裝

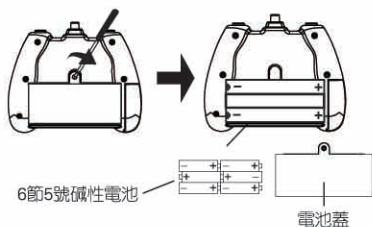

打開電池蓋依照電池箱內的電極指示正確的裝6節“AA”電池再蓋上電池蓋。

給飛機充電

A、遙控器充電

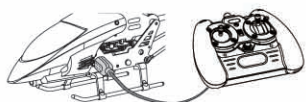

B、USB充電

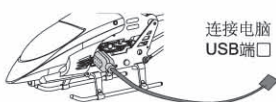

- 1、打開遙控器開關，將直升機上的開關撥到關的位置。
- 2、充電方法“A”：拉下遙控器上的充電門蓋并取出充電綫，然後將充電插頭連接到飛機的充電口上，遙控器上黃燈變為閃亮的紅燈；充電時間約40至50分鐘，遙控器上閃亮紅燈變為常亮黃燈時充電完成。

充電方法“B”：將USB充電綫插入電腦USB端口，此時充電綫燈亮；將USB充電插頭連接到飛機的充電口上，此時充電綫上的燈滅；充電時間約40至50分鐘，充電綫上燈亮時充電完成。

充電時間四十到五十分鐘可飛行約六至七分鐘

駕駛你的直升機

- 將遙控器開關掣拔至“ON”上，電源指示燈閃亮。
- 將直升機上的開關掣拔至“ON”上，電源指示燈閃亮。
- 將直升機放於地上并把直升機尾部朝向操作者。
- 當直升機接收到發射信號時，接收板指示燈為常亮狀態。

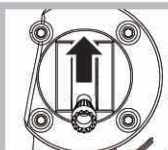

左手操作圖

- 1、打開電源開關。
- 2、動力手柄必須先推至最大控制行程，再歸置零位（最底位）才可以打開飛機電源進行正常操作。

上盤旋和下盤旋:

當直升機飛行穩定時，你可以慢慢地將變速杆向上推，直升機便會飛高。或將變速杆微微拉下，直升機便會向下飛行。要平穩飛行，祇需微微控制變速杆

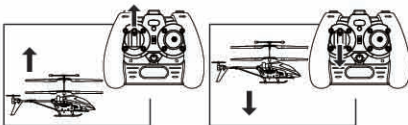

前進

當右操縱杆（轉向舵）向上推，直升機機頭向下。直升機向前前進。

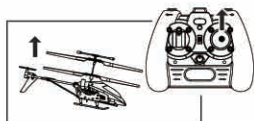

順時針轉和逆時針轉:

將方向杆推向左邊直升機便會逆時針轉。將方向杆推向右邊直升機便會順時針轉。

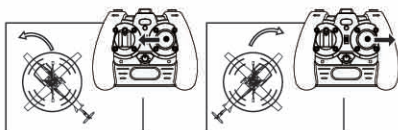

後退

當右操縱杆（轉向舵）向下推，直升機機頭向上。直升機向後後退。



注：當操作前進或後退飛機出現打轉，你同時可用方向舵來修正航綫。

飛行中如果沒有推動轉向操作杆，但直升機仍然在空中打轉，這時可以調整你手中遙控器上的微調旋鈕，直到直升機平衡不打轉為止。

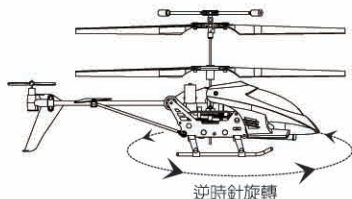

逆時針旋轉

機尾出現逆時針旋轉時，你可以順時針旋轉你手中遙控器微調旋鈕直至平衡。
注：機尾朝向操控者

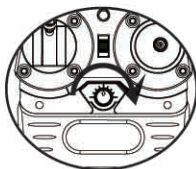

順時針旋轉
微調旋鈕

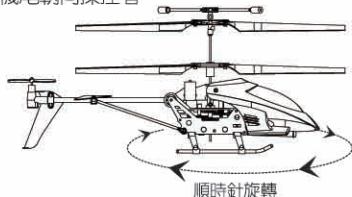

順時針旋轉

機尾出現順時針旋轉時，你可以逆時針旋轉你手中遙控器微調旋鈕直至平衡。
注：機尾朝向操控者



逆時針旋轉
微調旋鈕

操作指示：

- * 切勿在有陽光直接照射下或有強烈光綫的地方操作此玩具，這會影響直升機的控制系統。
- * 切勿遮蓋遙控器上的透鏡位，訊號有可能因此而不能接收。
- * 切勿在直升機上帖上其他貼紙，因有可能影響紅外線訊號接收。
- * 飛行類產品均使用輕薄材料，如果飛行操作不當易損壞；摔撞或其他因素均可能導致損壞。
- * 電機為發熱部件，請勿觸摸，以免燙傷。

飛行環境：

1. 平靜氣流的室內環境。請注意冷氣機引起的氣流。
2. 空曠地方。建議地方面積超過20尺（闊）X 30尺（闊）X 10尺（高）。
3. 安全地方。極力建議在沒有風扇、冷氣機、臺燈或其他危險物件等的地方駕駛此玩具。

配件（選購）

下列是可供選擇的配件，為方便客戶選購，特出每個部件、可通過當地的經銷商購買配件。



S105G-01
機頭



S105G-02
風葉



S105G-03
機尾飾件



S105G-04
鎖扣



S105G-05
平衡杆



S105G-06
尾風葉



S105G-07
主架



S105G-08
起落架

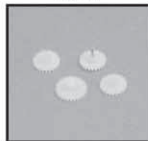

S105G-09
齒輪



S105G-10
尾撐管



S105G-11
主架鐵件A



S105G-12
主架鐵件B



S105G-13
主軸



S105G-14
機尾



S105G-15
主軸管



S105G-16
主電機A



S105G-17
主電機B



S105G-18
電路板



S105G-19
聚合物鋰離子電池